

# 19" ERATline 300 Series

Free Standing Cabinets

Width: 600 mm

Depth: 600/800 mm



#### Production Standards:

- ISO 9001:2015 - Quality Management System
- ISO 14001:2015 - Environmental Management System

#### Compliance:

- EN 61587-1 Mechanical structures for electronic equipment - Tests for IEC 60917 and IEC 60297 series
- Climatic and Environment: EN 61587-1/4.2, IEC60068-2-1, IEC60068-2-2, IEC60068-2-30
- Static Mechanical Load Lifting: EN 61587-1/5.2.1
- Static Mechanical Load Stiffness: EN 61587-1/5.2.2
- Dynamic Mechanical Load Vibration and Shock, Impact: EN61587-1/5.3.1, EN61587-1/5.3.3, IEC60068-2-6, IEC60068-2-27
- Earth Bond: EN61587-1/6.2
- Flammability: EN 61587-1/6.3
- Degrees of Protection Provided by Enclosures (Ip Code): IP20
- EN 13501-1+ A1- Epoxy Powder coated compliant to Fire classification of construction products and building elements Part 1: Classification using data from reaction to fire tests
- Epoxy Powder coating tested as per EN ISO 9227 and ASTM B 117 Corrosion tests in artificial atmospheres - Salt spray tests; minimum 1000 hours
- EN ISO 2409 Paints and varnishes - Cross-cut test
- EN ISO 2178 Non-magnetic coatings on magnetic substrates
- Measurement of coating thickness - Magnetic method
- RoHS Compliancy according to 2011/65/EU
- CE Compliant to EN 60950-1



Maximum load capacity up to 600 kg.



#### Free Standing ERATline 300 Series Cabinets

12U/16U/20U/22U W600xD600 mm and W600xD800 mm

- Multi folded modular design clamped with screws, coted with RAL 9005 epoxy polyester powder.
- Single point barrel locking glass front door and metal rear door. Removable side panels are lockable.
- 1 set of 19" front depth adjustable equipment mounting rails & 1 set of 19" rear fixed equipment mounting rails, U height numbered.
- Two 70x140mm PVC and brushed cable entrances located at the top and bottom of the cabinet, swappable during the field applications.
- Ventilation slots that can mount single or double fan modules for forced ventilation.
- Front glass door is covered by EN 12150-1 standard with 4,0 mm thick anti-static tinted smoke tempered glass and metal frame.
- Maximum load capacity up to 600 kg.
- 4 adjustable feet group included, replaceable by a castor set (optional).

# 19" ERATline 300 Series

Free Standing Cabinets

Width: 600 mm

Depth: 600/800 mm

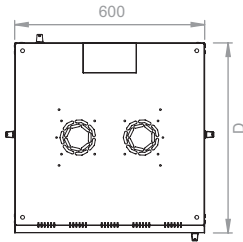

Top view

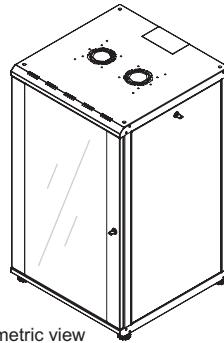

Isometric view

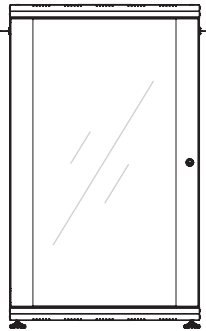

Front view

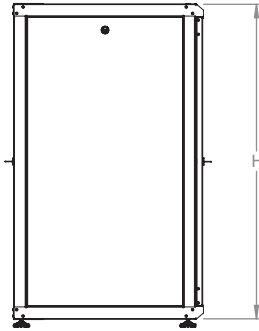

Side view

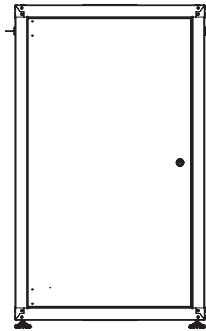

Rear view

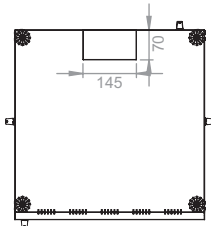

Bottom view

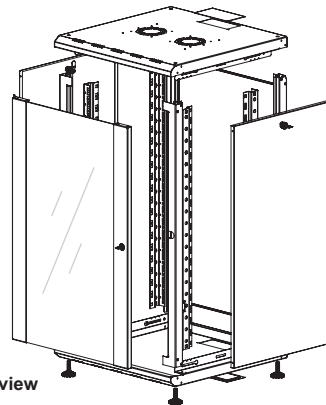

Exploded view



## 19" ERATline 300 Series Free Standing Cabinets W600 x D600 mm

Dimensions WxDxH mm	Package Size WxDxH mm	Product Description
600x600x640	650x650x656	12U 19" W600 x D600 mm Free Standing Cabinet
600x600x818	650x650x834	16U 19" W600 x D600 mm Free Standing Cabinet
600x600x996	650x650x1012	20U 19" W600 x D600 mm Free Standing Cabinet
600x600x1085	650x650x1101	22U 19" W600 x D600 mm Free Standing Cabinet

## 19" ERATline 300 Series Free Standing Cabinets W600 x D800 mm

Dimensions WxDxH mm	Package Size WxDxH mm	Product Description
600x800x640	650x850x656	12U 19" W600 x D800 mm Free Standing Cabinet
600x800x818	650x850x834	16U 19" W600 x D800 mm Free Standing Cabinet
600x800x996	650x850x1012	20U 19" W600 x D800 mm Free Standing Cabinet
600x800x1085	650x850x1101	22U 19" W600 x D800 mm Free Standing Cabinet

\* H length can be checked from the product dimensions.

# 19" ERATline 300 Series

## Free Standing Cabinets Accessories



Fan Modules for wall mounting cabinets, plug and play without reconfiguration, available with on/off switches or automatic analog thermostat . Each fan has an air flow capacity of 2,3-3 cbm/min. Fan technical data: 18/17 W, 220/240 VAC, 50/60 Hz, 013/0,11 A,2300/3000 rpm 42 dB noise level, Fan lifetime span: 50.000 hours.



Fan Module On/Off Switched Ball Bearing Long Life Fan - 50.000 Hours - Features	
Category	Product Description
Accessory	1 fan module on/off switched wall mounting type
Accessory	2 fan module on/off switched wall mounting type

Fan Module Thermostat Switched Ball Bearing Long Life Fan 50.000 Hours - Features	
Category	Product Description
Accessory	1 fan module thermostat switched wall mounting type
Accessory	2 fan module thermostat switched wall mounting type

\*CC= Color codification. Replace CC with BL for Black RAL 9005 Color and replace CC with LC for Light Grey RAL 7035 Color.

Fan Module On/Off Switched Ball Bearing Long Life Fan 50.000 Hours - Economic - Features	
Category	Product Description
Accessory	1 way fan module on/off switched
Accessory	2 way fan module on/off switched

Fan Module Thermostat Switched Ball Bearing Long Life Fan 50.000 Hours - Economic - Features	
Category	Product Description
Accessory	1 way fan module thermostat controlled
Accessory	2 way fan module thermostat controlled

\*CC= Color codification. Replace CC with BL for Black RAL 9005 Color and replace CC with LC for Light Grey RAL 7035 Color.

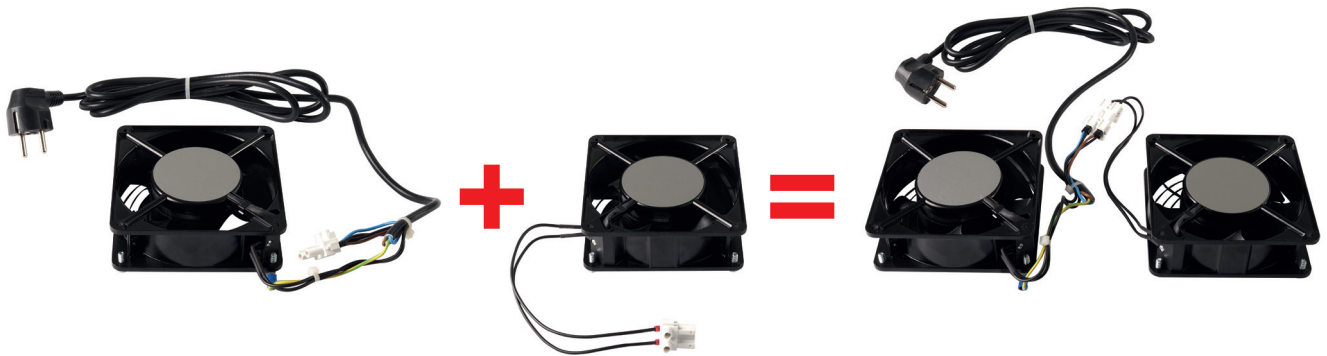

Economic Extendable Fan Modules - No any Metal Housing - Ball Bearing Long Life Fan- 50.000 Hours - Economic+	
Category	Product Description
Accessory	Single fan with grill 1,8 meter power cable DIN49441 Schuko Plug and extension terminal male ball bearing long life fan
Accessory	Single fan with grill extension terminal female ball bearing long life fan

\* LN-FAN-HL-1FBB-E is just a fan for making cabinet equipped with 2 fans used with main product LN-FAN-HL-1FBB-M and add the extension fan.